

# A NEW FLUX CONCENTRATOR MADE OF Cu ALLOY FOR THE SuperKEKB POSITRON SOURCE

Y. Enomoto\*, K. Abe, N. Okada, T. Takatomi, KEK, Tsukuba, Japan

## Abstract

A SLAC type Flux Concentrator (FC) [1] made of Cu alloy was developed to avoid discharge problem caused by deformation. Previous one is made of pure Cu whose electrical and thermal conductivity shows high value in exchange for poor mechanical strength especially after brazing. The new material shows 40 times higher yield strength than that of pure Cu after brazing. There is possibility to use the material not only for the FC but also for any other high current devices.

## INTRODUCTION

Flux concentrator (FC) is one of important device for positron source which translates position and momentum spread of the particles adiabatically to match them to the acceptance of the following section. To realize higher positron yield, higher magnetic field is desired. However, higher field by higher current generate stronger force on the coil. Since the gap between each turn of the coil is as narrow as 0.2 mm and the voltage across them is as high as 1 kV at the design peak current and pulse width, slight deformation of the coil cause discharge between the gap as shown in Fig. 1. To avoid such problem, a new FC made of Cu alloy which has 40 times higher yield strength even after the brazing than that of pure Cu was designed and tested.

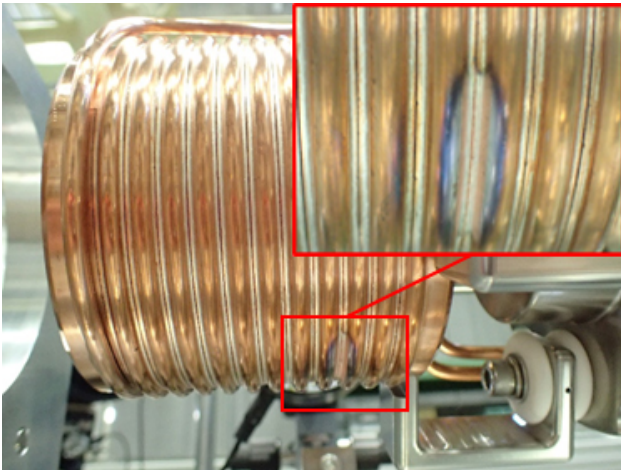

Figure 1: Typical discharge mark.

## MATERIAL CONSIDERATION

Considering the manufacturing process as listed in the following section, good brazing property is mandatory for the material. In addition to high yield strength to avoid

\* yoshinori.enomoto@kek.jp

deformation, electrical and thermal conductivity are also important. It is desired that the new material balances these properties at high level.

Three kinds of Cu alloy<sup>1</sup>, CrCu (SH-1), CrCuZr (SH-2) and CuNiSiCrSn (NC50) along with pure Cu (C1020) were evaluated by brazing and tensile test. Test pieces were heated up and cooled down following the profile shown in Fig. 2 in both tests.

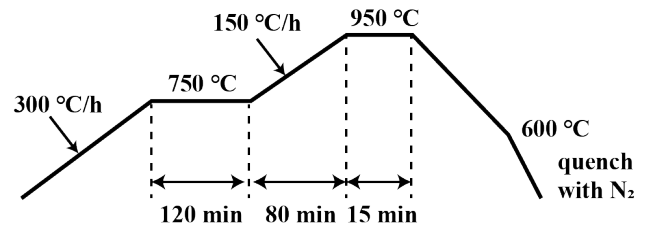

Figure 2: Temperature profile used for both brazing and tensile tests.

## Brazing Property

Figure 3 shows wettability of the brazing materials. A palladium (BPd-4) and a silver (BAG-8) brazing material were fixed by wire on the surface of each test pieces. The combination of NC50 and BAG-8 showed good result almost the same as the combination of C1020 and BAG-8. Wettability of SH-1 and SH-2 were poor and their surface color changed to dark silver from their original Cu-like color due to precipitation of some components in the alloy. For all of the test pieces, BAG-8 shows better result than that of BPd-4.

## Tensile Test

Bar shaped test pieces were prepared following the Japanese Industrial Standards (JIS) Z2241 type 4. Their mechanical properties were evaluated by tensile tester. Figure 4 shows results of NC50 (red) and C1020 (black) before (dashed) and after (solid) heat cycle shown in Fig. 2. Thick red solid line represents the result of NC50 after the aging process. Even after the heat cycle, NC50 shows much higher yield strength than that of C1020. More importantly, mechanical property of NC50 recover to almost original value by aging. The yield strength of the NC50 after aging is 40 times higher than that of C1020 after heat cycle. All the results are summarized in the Table 1.

## Electrical and Thermal Properties

Since the FC is operated at very high current, whose design value is 12 kA, to generate strong magnetic field,

<sup>1</sup> The names of the alloys, SH-1, SH-2, NC50 are product names of Yomato Gokin Co., Ltd. Details of their ingredients and properties are able to be found in their web cite [2].

Table 1: Summary of Mechanical and Electrical Properties of Tested Materials

material		C1020		SH-1		SH-2		NC50		
heat cycle		no	yes	no	yes	no	yes	no	yes	yes and aging
electrical conductivity	%IACS	102.2	102.1	90.8	76.0	81.1	68.5	50.3	25.1	48.8
hardness		87.4	30.4	71.6	60.0	45.9	55.8	95.3	61.2	95.4
tensile strength	MPa	327.4	232.1	402.6	237.2	443.1	238.3	648.7	323.7	658.8
elongation	%	21.6	54.4	36.8	56.8	32.6	51.4	14.8	46.6	10.6
yield strength	MPa	322.3	12.9	293.6	57.9	348.2	40.8	551.8	109.7	513.1

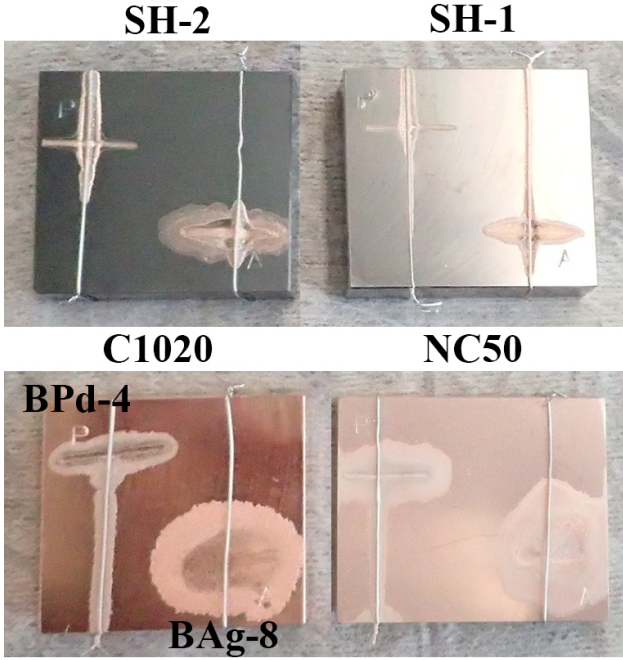

Figure 3: Results of brazing test.

electrical and thermal conductivity of the material are also important. As widely known as Wiedemann–Franz law, the ratio of thermal conductivity and electrical conductivity of metal is determined regardless of material. Electrical conductivity is evaluated by the eddy current conductivity meter (sigmachek2, Ether NDE). Results are also summarized in the Table 1 by international annealed copper standard (IACS). As its name suggest, electrical conductivity of the NC50 is 50% of that of pure Cu at initial state. After the brazing, the value gets as low as 25%, however, it gets recovered to its original value by aging. Figure 5 shows heat generation distribution by pulsed current simulated by CST studio. Due to the skin effect, pulsed current whose width is 6  $\mu$ s flows only the surface of the FC. Temperature distribution of the FC in operation at 12 kA looking from downstream side as indicated by the arrow in the Fig. 5 were measured by a infra-red camera (VIM-384G2EL, Vision Sensing) through a ZnSe window. The result is shown in the Fig. 6. The highest measured temperature was about 54 °C. Since the temperature of cooling water is 30 °C, the rise of temperature is 14 °C at the maximum. Total heat wasted to the cooling

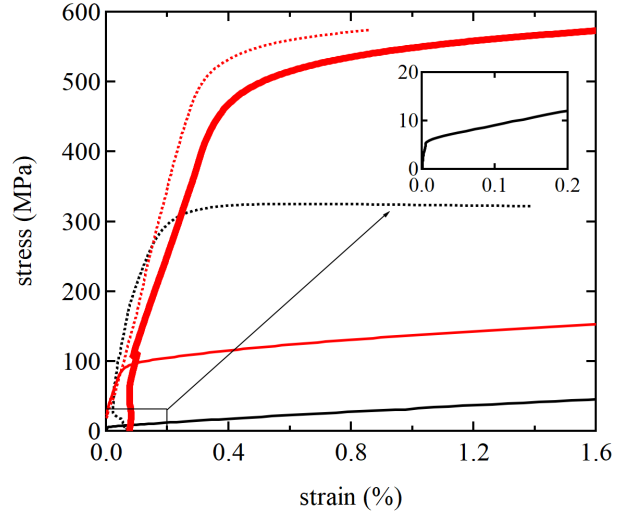

Figure 4: A strain-stress graph of NC50 (red) and C1020 (black). Dashed line shows the results before heat cycle and solid lines show the results after heat cycle. Thick red solid line shows the result of NC50 after heat cycle and aging. Inset shows expansion around origin.

water, which was calculated by flow rate and temperature rise of the cooling water was about 750 W.

## MANUFACTURING PROCESS

Manufacturing process of the FC made of NC50 is as follows.

- make groove outside and taper inside from the NC50 cylinder by lathe.
- braze Cu pipe to the NC50 block in a vacuum furnace. At the same time solution treatment was done choosing the brazing temperature as high as 950 deg.
- aging the NC50 block in the in a vacuum furnace.
- make 0.2 mm wide spiral slit by the special Wire Electric Discharge Machining (WEDM) which has cranked wire guide as shown in Fig. 7.
- assemble it to a vacuum flange with feedthrough, target and others.

The process are basically the same as those for the FC made of pure Cu except for the aging process. Operation parameters for the Wire Electric Discharge Machining (WEDM) were slightly changed from those for the pure Cu.

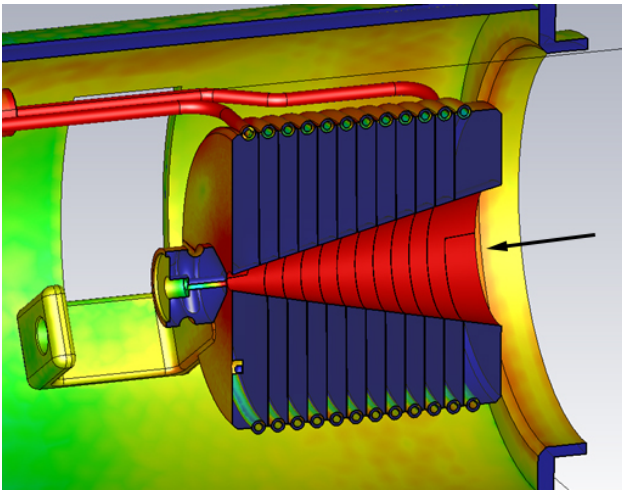

Figure 5: Heat generation distribution by pulsed current simulated by CST studio.

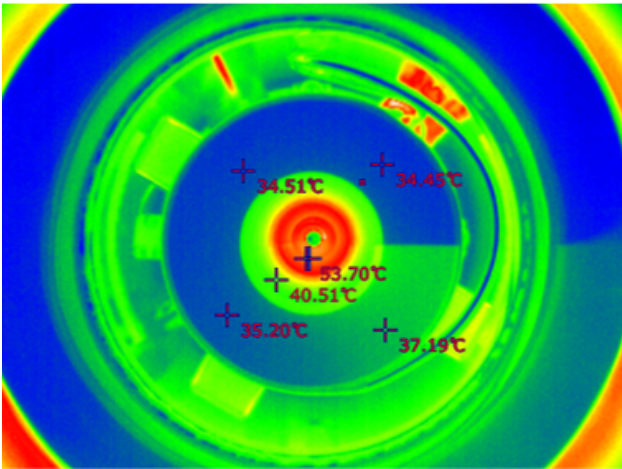

Figure 6: Temperature distribution of the FC in operation at 12 kA measured by infra-red camera from downstream side indicated by the arrow in Fig. 5.

## INSTALLATION AND OPERATION

After a few months of operation at Test bench, the new FC was installed into the beamline in September 2020. Since then, it has been in operation at full current, 12 kA, without discharge and any trouble. The positron yield measured at the first BPM after the e+/e- separation chicane increased from 0.25 to 0.58 as a result of installation of the new FC along with several another upgrade in the capture section.

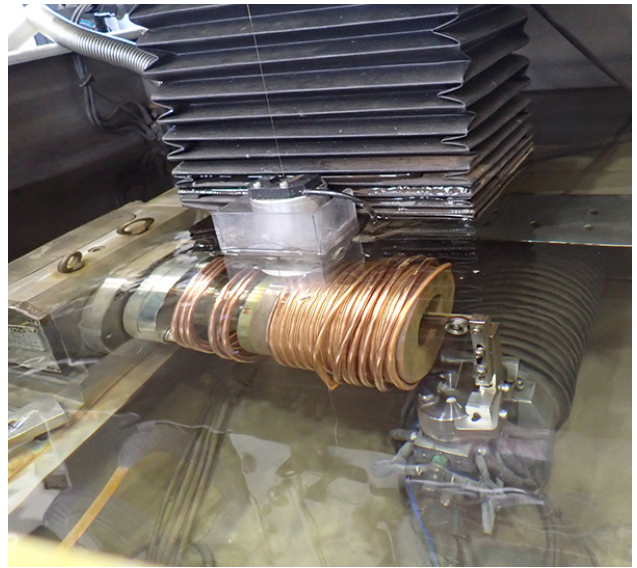

Figure 7: Wire Electric Discharge Machining of the FC.

## CONCLUSION

Several Cu alloys were evaluated from the mechanical and electrical point of view along with brazing property. These results might be useful considering an alternative material for high power accelerator components such as accelerator structure, which is usually made of pure Cu. The new FC made of NC50, was manufactured installed and has been used for positron production for the SuperKEKB project. Along with several another upgrades, positron yield drastically increased from 0.25 to 0.58.

## ACKNOWLEDGEMENTS

Authors thank Yamato Gokin Co., Ltd. and Miyoshi Gokin Kogyo Co., Ltd. for their support on material tests and technical advice especially about heat treatment.

## REFERENCES

- [1] A. V. Kulikov, S. D. Ecklund, and E. M. Reuter, "Slc Positron Source Pulsed Flux Concentrator", Stanford Linear Accelerator Center, Stanford, USA, Rep. SLAC-PUB-5473, June, 1991. <https://www.slac.stanford.edu/pubs/slacpubs/5250/slac-pub-5473.pdf>
- [2] Yamato Web, <https://www.yamatogokin.com/en/>