

STATUS OF MICROPHONICS ON CERL NINE-CELL CAVITIES

F. Qiu^{1,2,†}, S. Michizono^{1,2}, T. Miura^{1,2}, T. Matsumoto^{1,2}, D. Arakawa¹, H. Katagiri¹, E. Kako^{1,2},
H. Sakai^{1,2}, K. Umemori^{1,2}, T. Konomi^{1,2}, N. Liu², B. T. Du²

¹High Energy Accelerator Research Organization (KEK), Tsukuba, Ibaraki 305-0801, Japan

²The Graduate University for Advanced Studies (Sokendai), Hayama, Kanagawa 240-0193, Japan

Abstract

In the main linac (ML) of the compact energy recovery linac at KEK, two 1.3 GHz nine-cell superconducting cavities (ML1 and ML2) with high loaded Q ($Q_L > 1 \times 10^7$) are operated in continuous wave mode. Because of the narrow bandwidth of these cavities, the microphonics detuning have a significant impact on the achievable RF field stability. In this paper, we have analysed the microphonics performance of the two ML cavities. According to our study, a “field level dependence microphonics” phenomenon is observed on the ML1 cavity. Several frequency components higher than 500 Hz were suddenly excited if the cavity field is above an onset field (~ 3 MV/m). Although the mechanism for the phenomenon remains obscure, the onset field is probably related with the cavity quench limits. Finally, we confirmed that the deteriorated RF stabilities (due to the deteriorated microphonics) can be improved by applying a disturbance observer based control approach.

INTRODUCTION

A compact energy recovery linac (cERL) was constructed at KEK to demonstrate the feasibility of the future 3 GeV ERL based light source [1]. It is a 1.3 GHz superconducting (SC) test facility operated in the continuous-wave mode. In the main linac (ML) of the cERL, two nine-cell cavities (ML1 and ML2) with a high loaded Q (Q_L) of more than 1×10^7 were installed [2]. The beam commissioning for the ML was started at Dec. 2013. Since the cavity was operated with high Q_L , the microphonics detuning seriously disturbed the cavity phase.

Figure 1 compares the cumulative microphonics detuning as a function of the vibration frequency of the ML1 and ML2 cavities from year 2015 to 2019. The cavities were operated at different field according to the cavity condition and physical requirements. It is clear to see that there is a dominant vibration at around 50 Hz at 2015 (especially for the ML2 cavity). The main source for this vibration is from the scroll pumps. After inserted a rubber sheet under the pumps, the 50 Hz vibration was well suppressed as expected. The microphonics conditions in the past 4 years (except 2015) are in good consistence for the ML2 cavity. On the other hand, the microphonics detuning of the ML1 cavity increased year by year. Especially in 2019, two large vibrations at 680 Hz and 890 Hz were observed as shown in left subplot of Fig. 1.

Due to the deteriorated microphonics conditions of the ML1 cavity, the measured radio frequency (RF) stabilities

were getting worse as shown in Fig. 2 (left). The results are calibrated by the measured cavity pick up signals which are filtered by a 250 kHz fourth order digital low-pass filter [3]. The feedback (FB) parameters such as the proportional and integral (PI) gains in the low level RF (LLRF) were kept the same in all these measurements. It is clear to see that the RF stabilities (especially the RF phase stability) of the ML1 cavity deteriorated after 2016. Whereas the stabilities of ML2 cavity always performed well due to its similar microphonics conditions in the past five years.

In view of this situation, we have estimated the background microphonics of these two cavities carefully. We found that the microphonics on the ML1 cavity depends on its field level, but there is no obvious field level dependence of the microphonics on the ML2 cavity. In this paper, we first introduce the current microphonics conditions of the cERL ML cavities. The method to measure the microphonics with the LLRF systems is briefly discussed. In the next step, the field level dependence of the ML1 cavity is presented; furthermore, the possible reason for this dependence is investigated as well. Finally, a potential approach aiming to improve the RF stabilities under deteriorated microphonics detuning is presented.

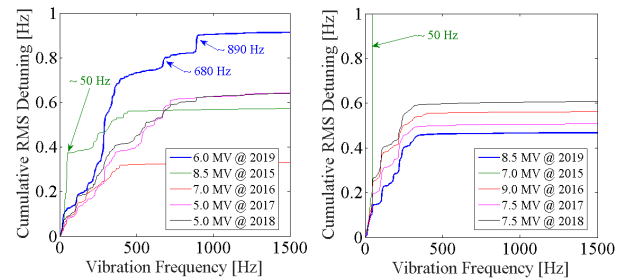

Figure 1: Cumulative RMS detuning as a function of the vibration frequency of the ML1 (left) and ML2 (right).

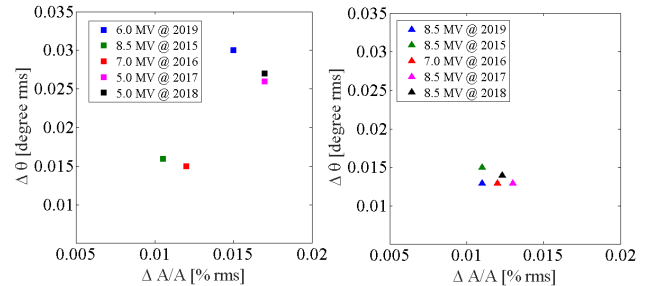

Figure 2: Amplitude and phase stabilities of ML1 cavity (left) and ML2 cavity (right) under FB operation in the past five years.

[†] qiufeng@post.kek.jp

LLRF SYSTEM

Figure 3 shows the digital LLRF systems and frequency tuner system of the ML cavities. The detailed information of these systems can be found in [4-5] and [6], respectively. As shown in Fig. 3, the baseband in-phase and quadrature (I/Q) components of the cavity pick-up signal and feedforward (P_f) signal are extracted in the LLRF system. In the next stage, the phase differences ($\Delta\phi$) between the above two signals are calculated. A 2.5 kHz first order digital low-pass filter is adopted to reduce the background noise as shown in Fig. 3 [6]. The microphonics detuning $\Delta\omega$ is then calibrated based on the $\Delta\phi$ by the equation

$$\Delta\omega = \omega_{0.5} \cdot \tan(\Delta\phi), \quad (1)$$

where $\omega_{0.5}$ represents the half-bandwidth of the cavity.

To evaluate the field dependence of the microphonics detuning, we gradually increased the cavity field by changing the set value of the LLRF FB loop under FB operation (see Fig. 3). The field-detuning map was then obtained by performing Fourier analysis of $\Delta\omega$ under different cavity field.

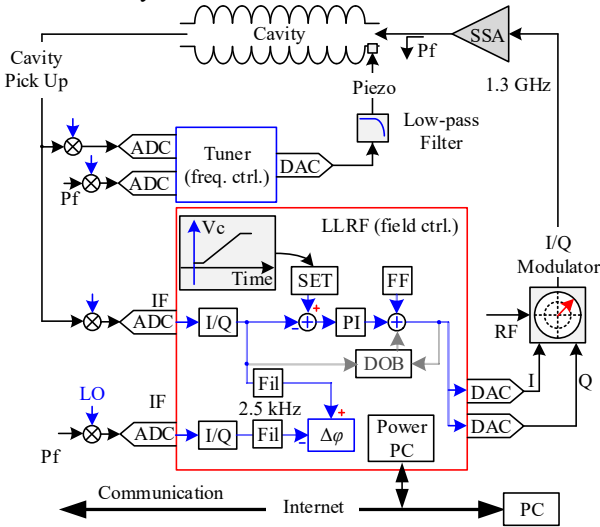

Figure 3: Schematic of the digital LLRF system and frequency tuner system of the cERL ML cavity.

MICROPHONICS OF ML CAVITIES

Figure 4 shows the measured field-detuning maps of ML1 (upper) and ML2 (lower) cavities. The color code in the map represents the detuning spectrum power. It is easy to see that there is a boundary on the map of ML1 cavity. The frequency components higher than 500 Hz were excited only if the cavity voltage (V_c) is larger than a 3.1 MV onset voltage. Figure 5 compares the microphonics spectrums of the ML1 cavity under the voltage close to the onset V_c . Several higher frequency components (>500 Hz) suddenly appeared as long as the V_c is slightly larger than 3.1 MV. The corresponding onset accelerating field, E_{acc} , is approximately 3 MV/m. The relationship between V_c and E_{acc} in the ML cavities is expressed as V_c [MV] = 1.038 [m] \times E_{acc} [MV/m], i.e. the value of V_c and

E_{acc} is almost same in our cavity [7]. There is no obvious dependence between the field and microphonics detuning in the ML2 cavity according to the lower subplot of Fig. 4. The detuning of the ML2 cavity is mainly concentrated on the frequency less than 500 Hz.

Figure 6 compares the RMS detuning of the two ML cavities as a function of their corresponding V_c . The intensity of the RMS detuning of ML1 cavity is increased if the cavity field is above the onset field. On the other hand, the RMS detuning of the ML2 cavity almost remains invariable. This is also in good agreement with the field detuning maps.

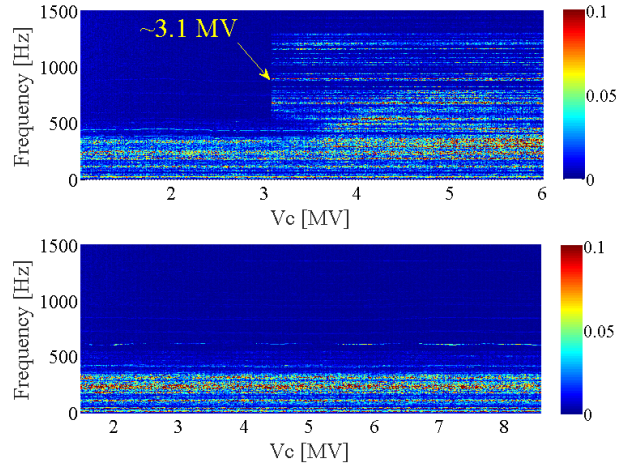

Figure 4: Field-detuning maps of ML1 (upper) and ML2 (lower) cavity. The color in the figure presents the intensity of the microphonics detuning.

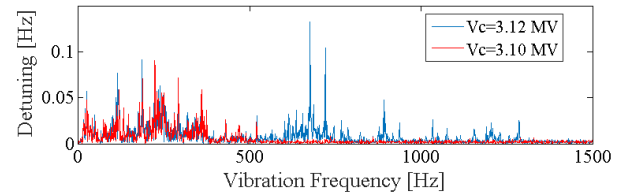

Figure 5: Microphonics spectrum comparison under the cavity field near the onset V_c .

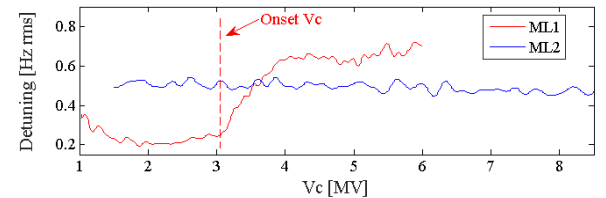

Figure 6: RMS detuning of the ML cavities as a function of V_c .

We scanned the field-detuning maps by several times under different LLRF conditions (switching on/off the LLRF field FB loops or the frequency tuner FB loop). The onset field was reproduced almost on the same value for all of these cases. A hysteresis phenomenon was observed in our experiment. The onset field was somewhat different when we scanned the field with different directions (increasing the field or decreasing the field). Table 1 has summarized the onset fields for all of these cases during

the experiments. We therefore conclude that the onset field is not related with LLRF FB conditions.

We found that the value of the onset field is probably related with the cavity quench limits. The cavity quench threshold field was increased by performing the pulse (PS) aging before the beam operation. It was very interesting to see that the onset field was also increased after PS aging. We observed that the quench threshold field was slightly decreased after one week beam operation, and the onset voltage was decreased as well. This variation of the onset field under different quench limits are summarized by Table 2. The mechanism for this phenomenon remains obscure so far. More study time will be required in the next cERL beam commissioning. To confirm whether the quench limits is the reason or not, we plan to operate the ML1 cavity with the $8\pi/9$ mode instead of π mode [3]. We expect that the quench limits will be changed under different passband mode, as a result, the onset field will be also varied if a dependence exists.

Table 1: Onset field under different LLRF conditions.

Round No.	Onset E_{acc} (field inc.)	Onset E_{acc} (field dec.)	Field FB	Tuner FB
1	3.11 MV/m	2.80 MV/m	ON	ON
2	3.12 MV/m	2.82 MV/m	ON	ON
3	3.12 MV/m	2.80 MV/m	ON	OFF
4	3.11 MV/m	2.82 MV/m	ON	OFF
5	3.12 MV/m	Unmeasured	OFF	ON
6	3.15 MV/m	Unmeasured	OFF	ON

Table 2: Onset field versus quench limit field.

Cavity Conditions	Onset E_{acc}	Quench Limits
Before PS aging	3.0 MV/m	5.9 MV/m
After PS aging	3.2 MV/m	6.3 MV/m
After one week operation	3.1 MV/m	6.1 MV/m

DOB CONTROL

As discussed above, the microphonics detuning deteriorated in the past several years, as a result, the cavity phase stability was getting worse. Figure 7 has compared the RMS detuning and cavity phase stability when scanning the field of the ML1 cavity. It is easy to find that the cavity RMS phase stability varies following the microphonics detuning. As mentioned above, the 2.5 kHz low-pass filter was applied in this measurement to reject the effects of the background noise (see Fig. 3).

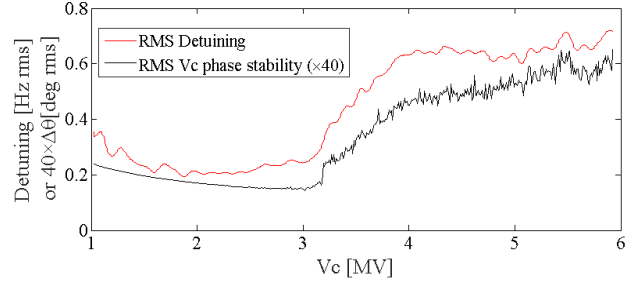

Figure 7: RMS V_c phase stability varies with the RMS detuning in the ML1 cavity.

Disturbance observer (DOB) based control is a possible solution to improve the RF stabilities. It is an advanced control approach that aims at rejecting the external disturbances in a control system. Since the microphonics detuning can be seen as a kind of external disturbances, we have applied the DOB method in our LLRF systems as shown in Fig. 3. The detailed information of this method is given in [5-6].

Figure 8 compares the case of with and without DOB control, and the improvement is obvious due to the microphonics induced phase fluctuation is almost disappeared after switching on the DOB control. The phase stability of ML1 cavity is improved from 0.028 degree rms to 0.013 degree rms.

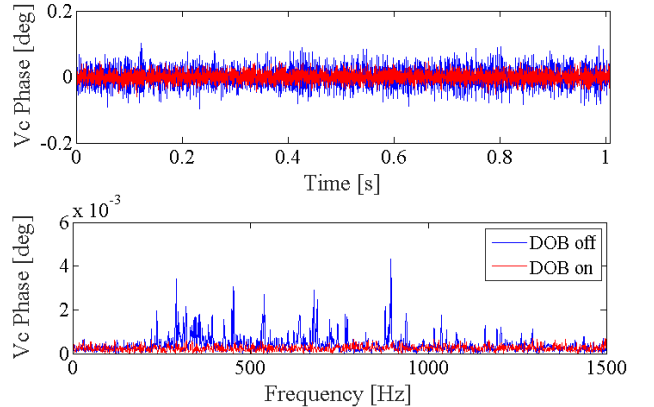

Figure 8: Measured ML1 V_c phase in the case of with and without DOB control. Upper: waveform. Lower: FFT result.

SUMMARY

After a long term operation, the microphonics detuning of ML1 cavity was increased. The field dependency microphonics maps were obtained by scanning the cavity field. The frequency components higher than 500 Hz were excited in the ML1 cavity if its field is above the onset field (~ 3.0 MV/m). This field is probably related with the quench limits although the internal mechanism is still not well understood. Due to the deteriorated microphonics conditions of the ML1 cavity, the performance of RF system, especially the phase stability were getting worse. After applying the DOB control, the phase stability of ML cavity was improved as expected.

REFERENCES

- [1] M. Akemoto *et al.*, “Construction and commissioning of compact energy-recovery linac at KEK”, *Nucl. Instr. Meth.*, vol. 877, pp. 197-219, 2018.
doi:10.1016/j.nima.2017.08.051
- [2] H. Sakai *et al.*, “Long-term Operation with Beam and Cavity Performance Degradation in Compact-ERL Main Linac at KEK”, in *Proc. LINAC’18*, Beijing, China, Sep. 2018, pp. 695-698. doi: 10.18429/JACoW-LINAC2018-THPO008
- [3] F. Qiu *et al.*, “Digital filters used for digital feedback system at cERL,” in *Proc. LINAC’14*, Geneva, Switzerland, Aug.-Sep. 2014, pp. 227-229.
- [4] T. Miura *et al.*, “Low-Level LLRF system for cERL”, in *Proc. IPAC’10*, Kyoto, Japan, May 2010, pp. 1440-1442.
- [5] F. Qiu *et al.*, “Application of disturbance observer-based control in low-level radio-frequency system in a compact energy recovery linac at KEK”, *Phys. Rev. ST Accel. Beams*, vol. 18, p. 092801, Sep. 2015.
doi: 10.1103/PhysRevSTAB.18.092801
- [6] F. Qiu *et al.*, “Progress in the work on the Tuner control system of the cERL at KEK”, in *Proc. IPAC’16*, Busan, Korea, May 2016. Pp.2742-2745.
doi: 10.18429/JACoW-IPAC2016-WEFOR033
- [7] H. Sakai *et al.*, “Field emission studies in vertical test and during cryomodule operation using precise x-ray mapping system”, *Phys. Rev. Accel. Beams*, vol. 22, p. 022002, Feb. 2019. doi: 10.1103/PhysRevAccelBeams.22.022002