

Upgrade of Event Timing System at SuperKEKB

**H. Kaji, K. Furukawa, M. Iwasaki, E. Kikutani, T. Kobayashi,
F. Miyahara, T.T. Nakamura, M. Suetake, M. Tobiya**
(KEK, Japan)

T. Okazaki
(East Japan Institute of Technology Co., Ltd, Japan)

T. Kudo, S. Kusano
(Mitsubishi Electric System & Service Co., Ltd, Japan)

SuperKEKB

SuperKEKB at KEK

- an electron-positron collider
- center of mass energy: 10.58GeV, $\Upsilon(4S)$ resonance
- upgrade of KEKB
- will start commissioning in early 2015.

Designed luminosity: $8 \times 10^{35} \text{ cm}^{-2} \text{ s}^{-1}$

- 40 times larger luminosity than the KEKB achievement (Note, KEKB achieved the world's largest luminosity for colliders.)
- Enhancement strategy consists of
 - 2 times larger storage beam current
 - 20 times smaller vertical beta function at interaction point

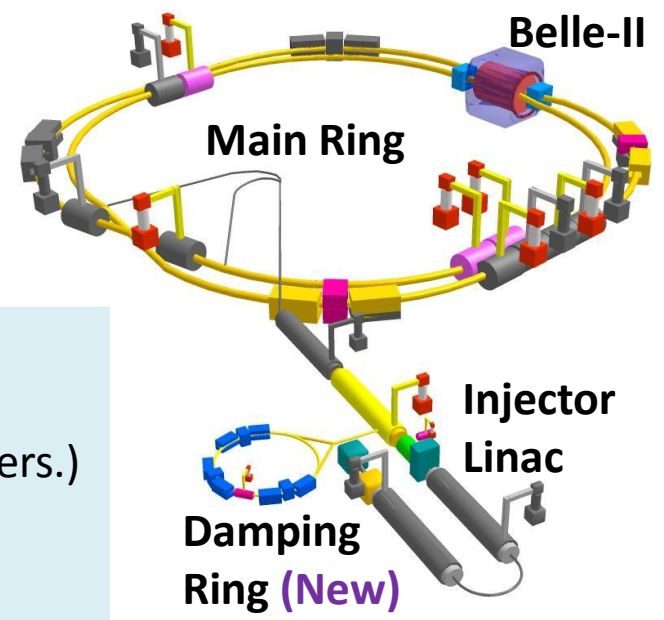

Requirements to Injector Linac

- storage beam current at Main Ring (MRs): doubled
- Low emittance beam: Need Damping Ring (DR) for positrons

	Electron beam		Positron beam	
	KEKB	SuperKEKB	KEKB	SuperKEKB
Energy	8 GeV	7 GeV	3.5 GeV	4 GeV
Beam current	1.64 A	3.6 A	1.19 A	2.6 A

$\xrightarrow{\text{x2}}$

$\xrightarrow{\text{x2}}$

More sophisticated injection control is needed.

Requirements to Injection Control

Injector Linac provides beams into 4 rings.

Injection control needs to be
more efficient and *complicated* at SuperKEKB.

Direction	Particle	Energy	Charge
KEKB HER	e^-	7.0 GeV	5.0 nC
KEKB LER	e^+	4.0 GeV	4.0 nC
PF	e^-	2.5 GeV	0.2 nC
PF-AR	e^-	6.5 GeV	5.0 nC

Top-up injection *more complicated*

- change rate of Linac parameters: typically 50Hz.
- number of top-up rings: 3 rings \Rightarrow 4 rings

Storage beam current at MRs *more efficient*

- doubled from KEKB
- beam lifetime: a few tens of min \Rightarrow 5min

DR for positrons *more complicated*

- makes injection scheme complicated
- affects Ring Selection and Bucket Selection
(they are described more detailed in the later slides.)

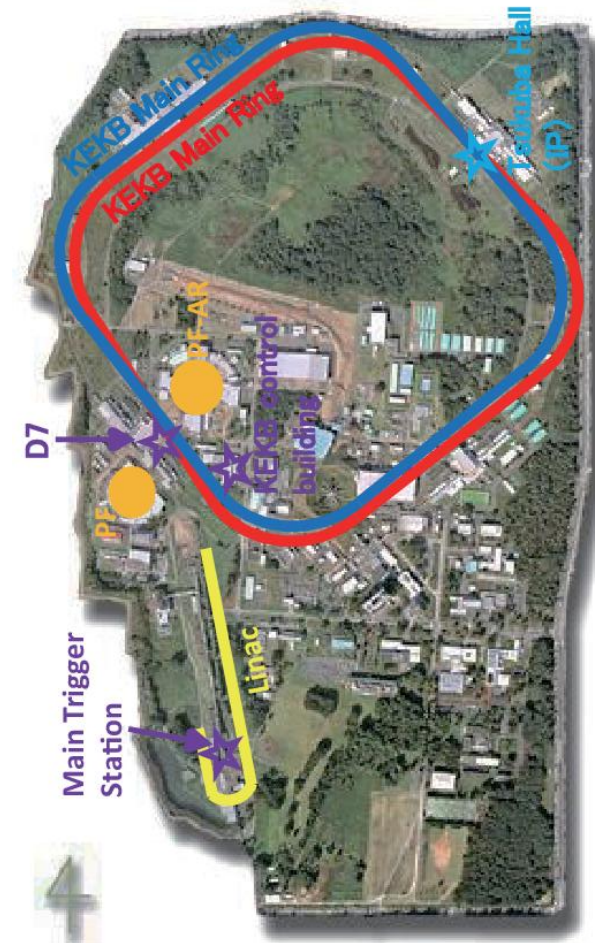

Ring Selection

Linac { arbitrates requests from individual rings and schedules the injection process.
performs injections by changing the injection ring in 50Hz.

They are needed for the top-up injection into more than one ring.

The Event Timing System is used to change more than 150 of Linac parameters in 50Hz.

Following new functions are needed for the Event Timing System at SuperKEKB.

The sequence must be longer than 20ms, one injection period in 50Hz since injection process of positrons extend 20ms.

Positrons are stored at DR for at least 40ms.

The programming of sequence needs to know long-term schedule since DR storage time depends on injection rate of positrons.

Two sequence can be run in parallel since more than one injection processes are implemented in parallel.

- Electrons are injected during positron damping.
- The 1st and 2nd halves of Linac work separately.

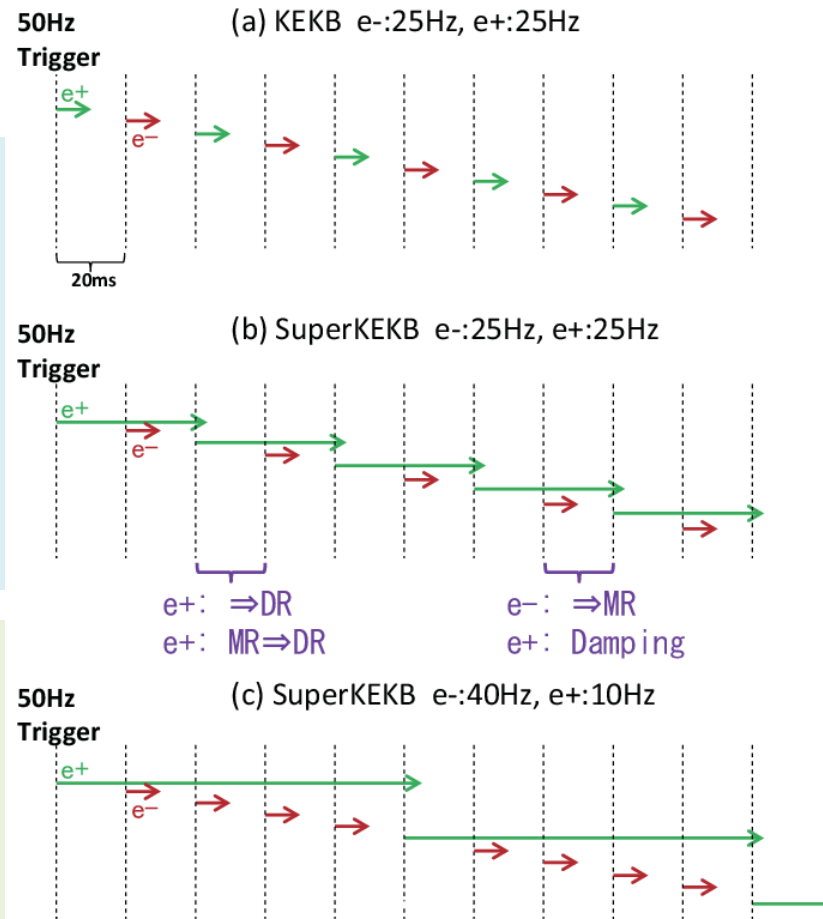

Bucket Selection

The injection RF-bucket of ring is selected by using the delay time.

- In each 20ms period, injection process is synchronized with the reference signal.
- Individual rings have the reference signal which is made from the revolution.
- In case of MRs, we controlled this delay time to select the targeting RF-bucket.
- The delay time of 0 – 493 μ s in the unit of 96.3ns.

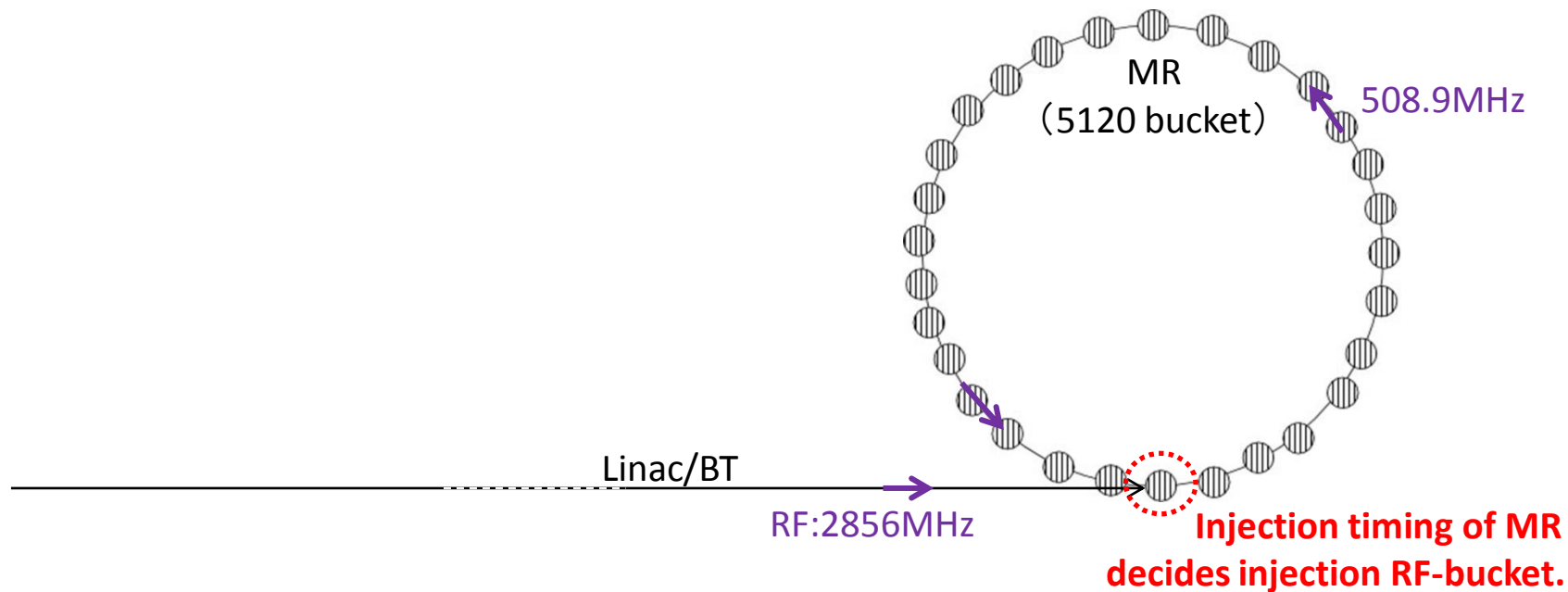

Bucket Selection at SuperKEKB

The injection RF-bucket of ring is selected by using the delay time.

- In each 20ms period, injection process is synchronized with the reference signal.
- Individual rings have the reference signal which is made from the revolution.
- In case of MRs, we controlled this delay time to select the targeting RF-bucket.
- The delay time of 0 – 493 μ s in the unit of 96.3ns.

Extraction timing of DR and **injection timing of MR** must be synchronized.

⇒ Bucket Selection for DR also needed.

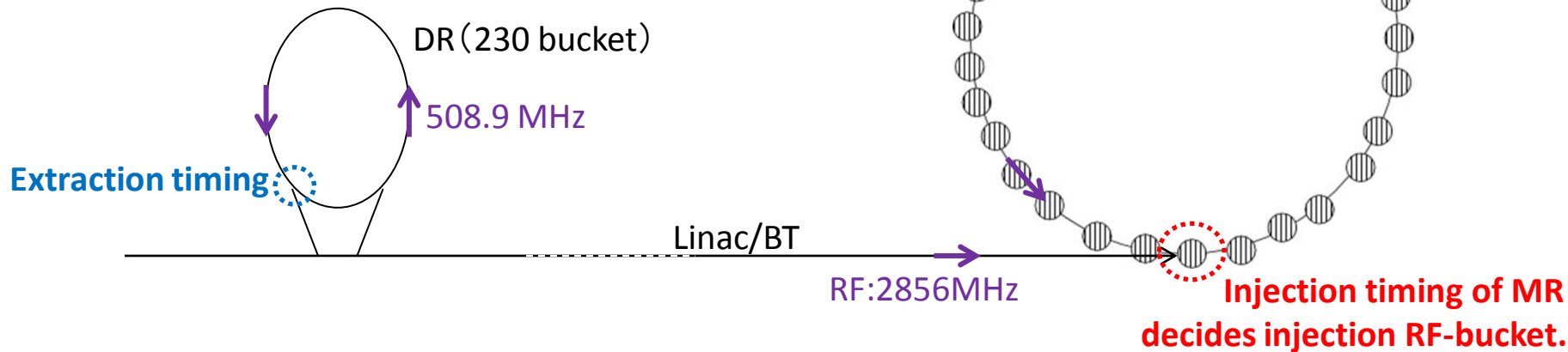

We choose harmonic number of 230 so that 23 kinds of combination between DR and MR are made.



The delay time of 0 – 11.34ms ($=493\mu\text{s} \times 23$) is needed when we control both DR-bucket and MR-bucket with the same method.

New requirements to Event Timing System

Mostly for positrons injection via DR

Top-up injection into 4 rings

⇒ Small change of trigger configuration, *skip today*

The sequence becomes longer than one injection period.

The programming of sequence needs to know long-term schedule.

⇒ **or long-term sequence should be programmed in advance.**

Two sequence can be run in parallel.

Bucket Selection for positrons needs the 11.34ms cycle of reference signal and the delay time, 0 – 11.34ms.

⇒ **Difficulty is in the synchronization**

between master 50Hz trigger and the reference signal.

The new configuration of Event Timing System is developed.

Event Timing System at SuperKEKB

AC 50Hz
11.34ms cycle

coincidence
TTL
($<50\text{Hz}$)



DR • MR

Upper-layer EVG

- receives coincidence trigger of master 50Hz and 11.34ms cycle.
- generates "Event" in 50Hz.
- Event becomes injection trigger.

Lower-layer EVGs

- deliver "Event" to local devices
- add the delay time for Bucket Selection.
- Relation between individual triggers and 11.34ms cycle is precisely controlled by upper-EVG.

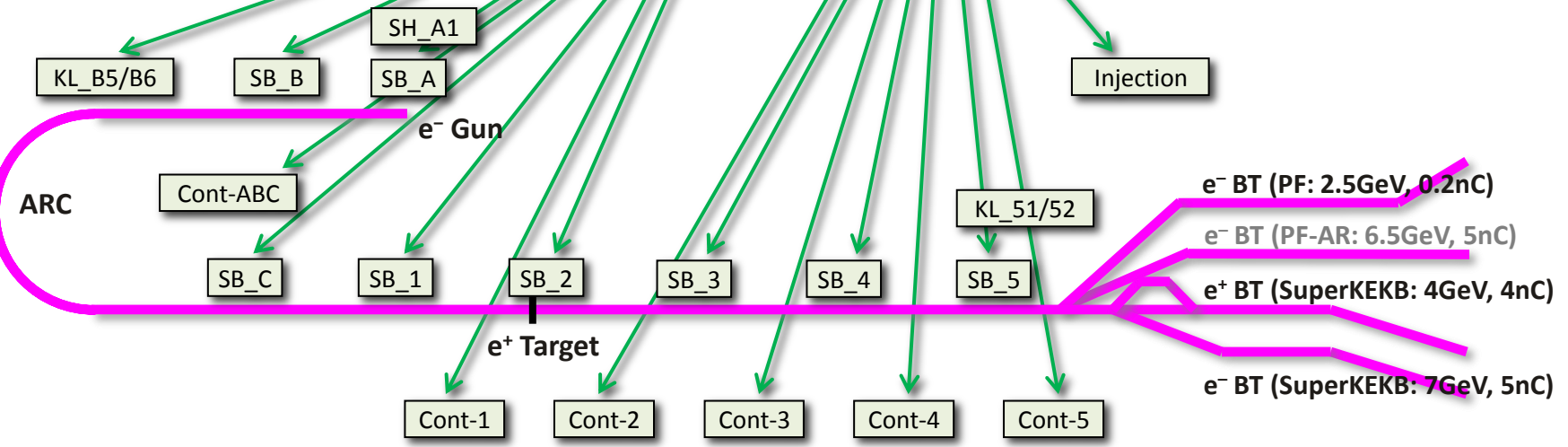

EVRs

Feasibility study

Followings are key elements for our new configuration:
 Two-layers of EVGs configuration
 operation with long term, a few seconds, sequence
 Their feasibilities are studied. The accuracy of output should be $O(100)ps$.

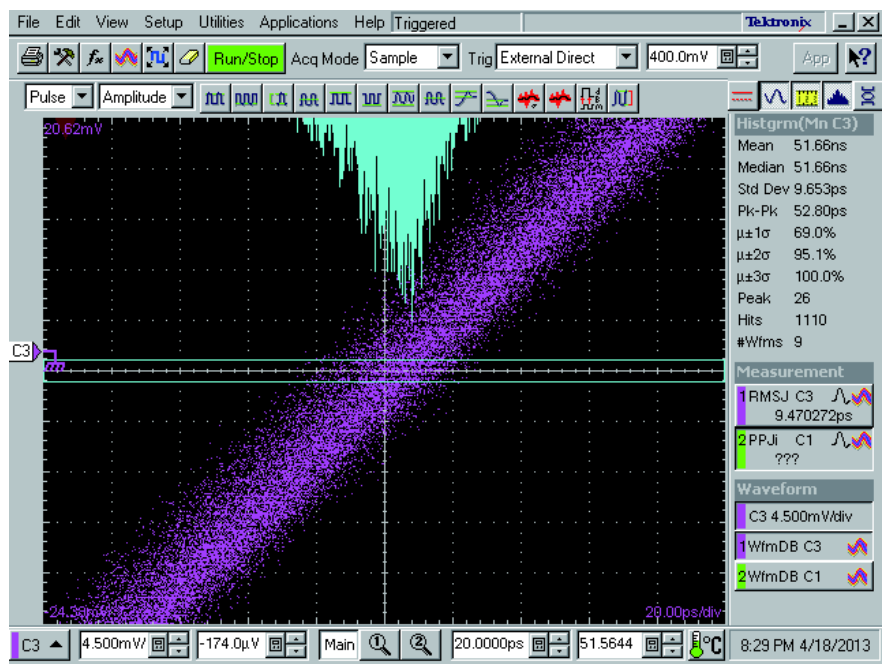
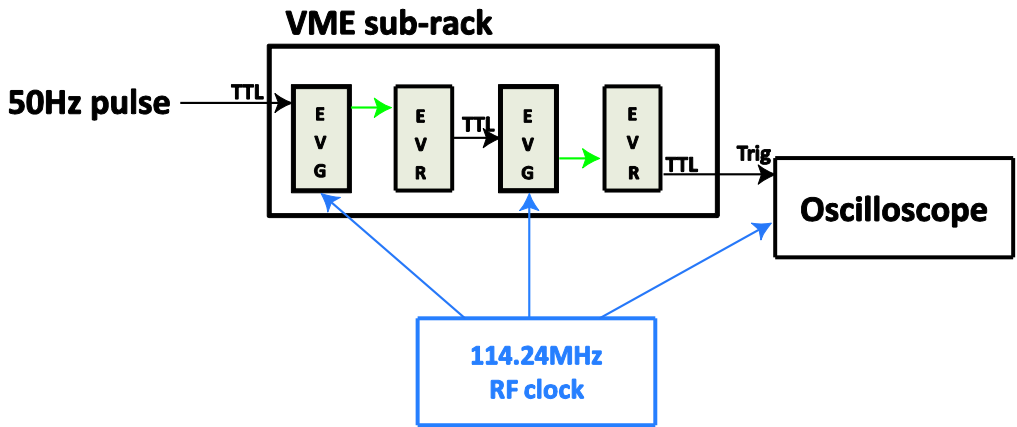

Two layers EVGs are configured for feasibility test.
 EVGs are synchronized with 114.24MHz clock.
 Timing of output TTL is tested as a reference of 114.24MHz clock.
 Oscilloscope with equivalent time sampling is used for measurement accuracy $< 1ps$.

After collecting 1000 samples, timing and its jitter is determined from center value and standard deviation of distribution.

Sequence length

Upper-layer EVG is operated with long-term sequence and send an Event at the end of sequence.

The output of lower-layer EVG is tested.

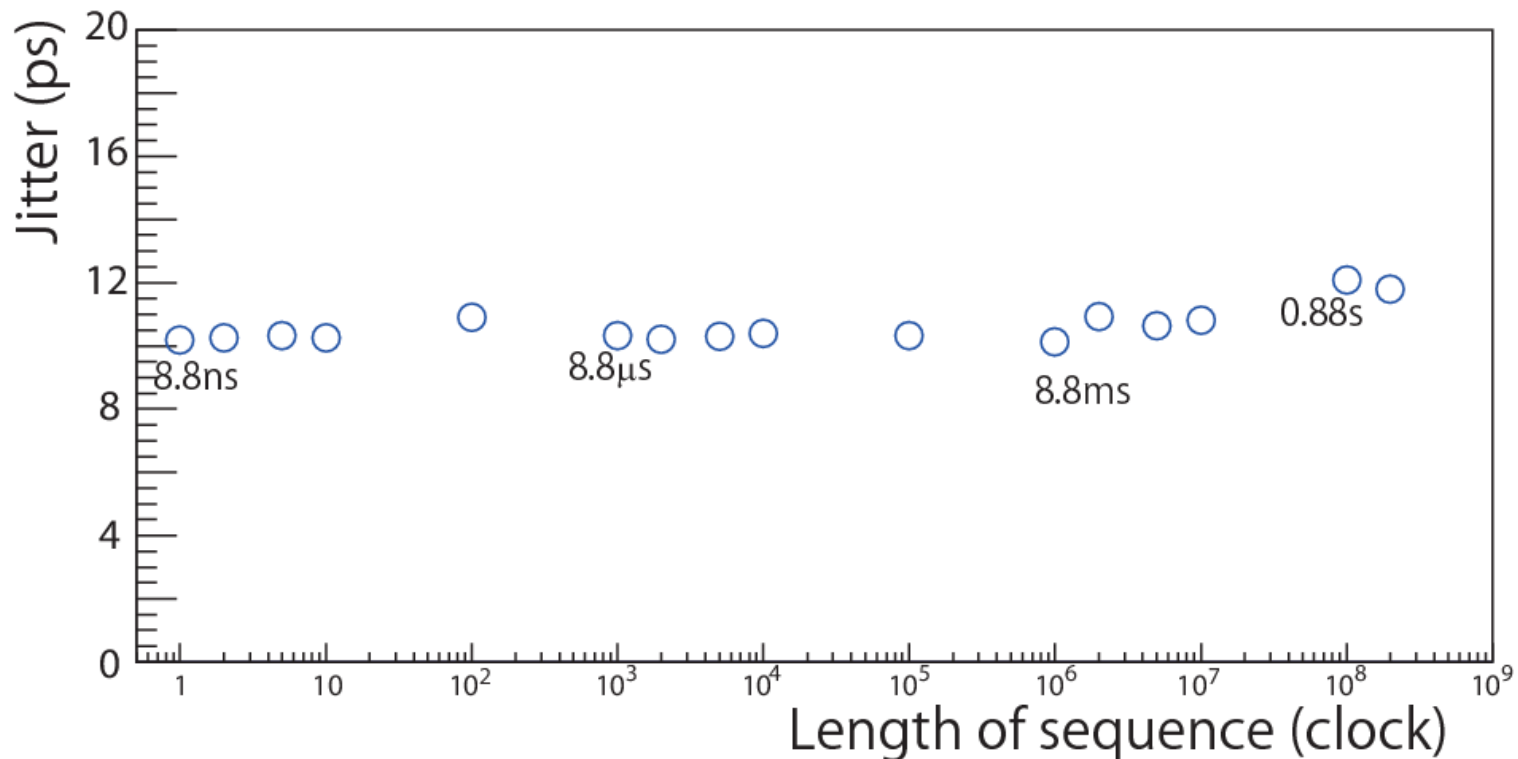

The jitter is always to be ~10ps.

There is no significant difference in the length of sequence.

Long term stability

The test setup is operated for 5 days continuously.
The timing and jitter are determined in every one-minute.

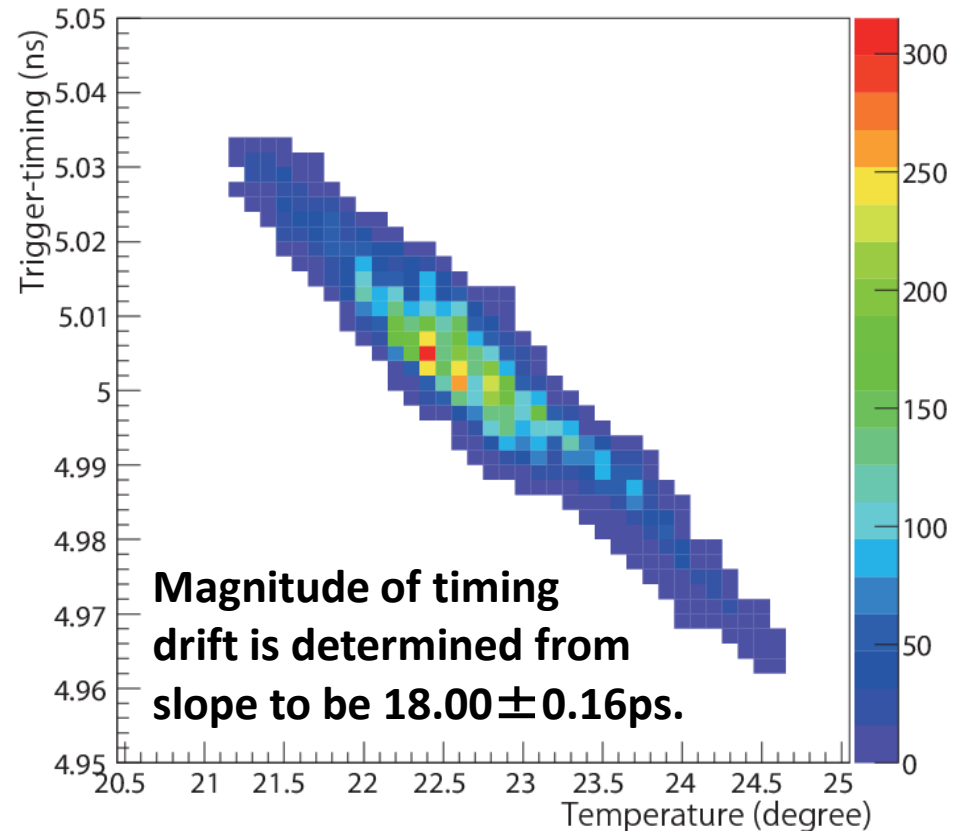
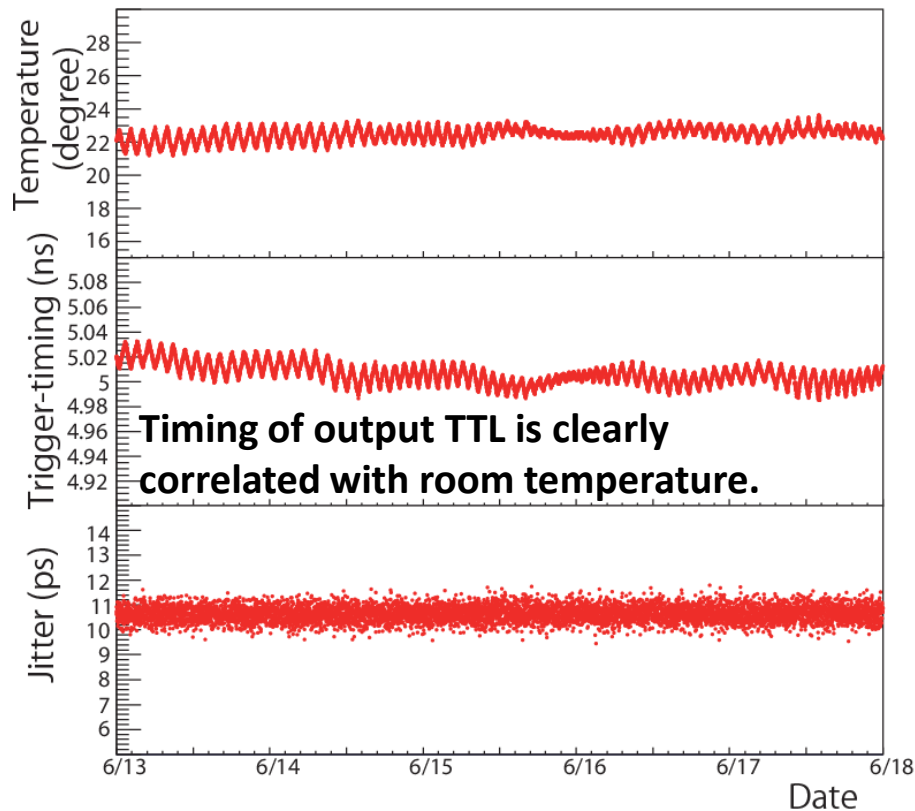

We found out there is correlation between timing and room temperature.

However It is no problem when we can control room temperature within 1 degree by using air conditioning.

Conclusion

The injection control becomes complicated at SuperKEKB.

- Number of top-up injection ring: 3 \Rightarrow 4.
- More than one process are implemented in parallel.
- 1st and 2nd halves of Linac are operated separately in case of positrons.

The Event Timing System is upgraded.

- Two-layers of EVGs are configured at Main Trigger Station.
- Upper-layer EVG generates 50Hz injection trigger.
- Lower-layer EVG add the delay time for Bucket Selection.

The feasibility study for new configuration is carried out.

- The timing accuracy of output trigger is to be ~ 10 ps.

Long-term stability is tested.

- The timing drift of 18ps/degree is observed.
- It is no problem when we can control room temperature within 1 degree.

Above results satisfies the required accuracy of O(100)ps.

We conclude the new configuration is no problem for SuperKEKB.